

DS-8000 Series Patient Monitor Accessory List





How to order

If you would like to order accessories email/call Customer Support at **(800) 365-6668** or **CustomerService@fukudaamerica.com** and list the following:



Customer number



Ship to address



P.O. number

x2
Quantity

Item number

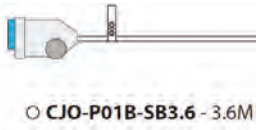

DS-8000 Series Accessory List TABLE OF CONTENTS

<p>NEW DS-8007 Transport Monitor 2</p> <p style="padding-left: 20px;">Configuration..... 3</p> <p style="padding-left: 20px;">ECG 4</p> <p style="padding-left: 20px;">NIBP..... 4</p> <p style="padding-left: 20px;">NIBP..... 5</p> <p style="padding-left: 20px;">IBP..... 5</p> <p style="padding-left: 20px;">SpO2..... 6</p> <p style="padding-left: 20px;">Temperature..... 6</p> <p style="padding-left: 20px;">CO..... 7</p> <p style="padding-left: 20px;">EtCO2..... 7</p> <p style="padding-left: 20px;">BIS™..... 8</p> <p style="padding-left: 20px;">Print..... 8</p> <p style="padding-left: 20px;">Other..... 8</p> <p>NEW DS-8400 Bedside Monitor 9</p> <p style="padding-left: 20px;">Configuration..... 10</p> <p style="padding-left: 20px;">ECG 11</p> <p style="padding-left: 20px;">NIBP..... 12</p> <p style="padding-left: 20px;">IBP 13</p> <p style="padding-left: 20px;">SpO2..... 13</p> <p style="padding-left: 20px;">Temperature..... 14</p> <p style="padding-left: 20px;">CO..... 14</p> <p style="padding-left: 20px;">EtCO2..... 15</p> <p style="padding-left: 20px;">BIS™..... 16</p> <p style="padding-left: 20px;">Print..... 17</p> <p style="padding-left: 20px;">Agent..... 17</p> <p style="padding-left: 20px;">Other..... 17</p> <p>DS-8100 Portable Bedside Monitor 18</p> <p style="padding-left: 20px;">ECG..... 19</p> <p style="padding-left: 20px;">NIBP..... 19</p> <p style="padding-left: 20px;">NIBP..... 20</p> <p style="padding-left: 20px;">IBP..... 20</p> <p style="padding-left: 20px;">SpO2..... 21</p> <p style="padding-left: 20px;">Temperature..... 21</p> <p style="padding-left: 20px;">CO..... 21</p> <p style="padding-left: 20px;">EtCO2..... 22</p> <p style="padding-left: 20px;">Print..... 22</p> <p style="padding-left: 20px;">Other..... 22</p>	<p>DS-8200 Transport Monitor..... 23</p> <p style="padding-left: 20px;">Configuration..... 24</p> <p style="padding-left: 20px;">ECG 25</p> <p style="padding-left: 20px;">NIBP..... 25</p> <p style="padding-left: 20px;">NIBP..... 26</p> <p style="padding-left: 20px;">IBP..... 26</p> <p style="padding-left: 20px;">SpO2..... 27</p> <p style="padding-left: 20px;">Temperature..... 27</p> <p style="padding-left: 20px;">CO..... 28</p> <p style="padding-left: 20px;">EtCO2..... 28</p> <p style="padding-left: 20px;">Print..... 29</p> <p style="padding-left: 20px;">Other..... 29</p> <p>DS-8500 Bedside Monitor 30</p> <p style="padding-left: 20px;">Configuration..... 31</p> <p style="padding-left: 20px;">ECG..... 32</p> <p style="padding-left: 20px;">NIBP..... 33</p> <p style="padding-left: 20px;">IBP..... 34</p> <p style="padding-left: 20px;">SpO2..... 34</p> <p style="padding-left: 20px;">Temperature..... 35</p> <p style="padding-left: 20px;">CO..... 35</p> <p style="padding-left: 20px;">EtCO2..... 36</p> <p style="padding-left: 20px;">BIS™..... 37</p> <p style="padding-left: 20px;">Print..... 38</p> <p style="padding-left: 20px;">Agent..... 38</p> <p style="padding-left: 20px;">Other..... 38</p> <p>DS-8900 Central Station..... 39</p> <p style="padding-left: 20px;">Print..... 40</p> <p style="padding-left: 20px;">Other..... 40</p>
--	--

DS-8007 TRANSPORT MONITOR





DS-8007N - Nellcor™ Model
DS-8007M - Masimo® Model

			Optional:	

Configuration

— Standalone —



DS-8007N - Nellcor™ Model
DS-8007M - Masimo® Model

*Required to have AC Power



DSA-81 AC Unit

— To Connect to DS-8400 —

Dock on the Back



DS-8007N - Nellcor™ Model
DS-8007M - Masimo® Model

OR



DS-8400
 Bedside Monitor

Module Connection Cable

*Connect to Main Unit DSC-8410

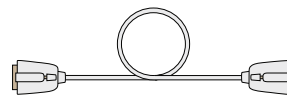

- **CJO-08SS1.5** (1.5M)

Special Order Item

- **CJO-08SS0.3** (0.3M)
- **CJO-08SS3.5** (3.5M)
- **CJO-08SS5** (5M)



DSA-82
 DS-8007 Adapter

— To Connect to DS-8500 —



DS-8500
 Bedside Monitor

Module Connection Cable

*Connect to Main Unit DSC-8530

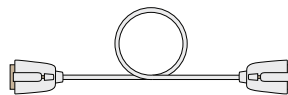

- **CJO-08SS1.5** (1.5M)

Special Order Item

- **CJO-08SS0.3** (0.3M)
- **CJO-08SS3.5** (3.5M)
- **CJO-08SS5** (5M)



DSA-82
 DS-8007 Adapter

ECG



DS-8007
Main Unit



○ **CIO-07CTP-3NA** - 3 Lead ECG Trunk Cable

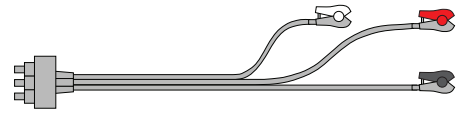

○ **CMO-07FT-3NAB** - 3 Lead ECG Patient Cable



○ **CIO-07CTP-4NA** - 4 Lead ECG Trunk Cable

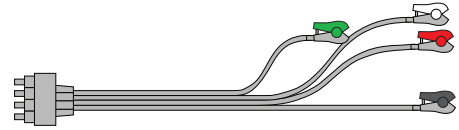

○ **CMO-07FT-4NAB** - 4 Lead ECG Patient Cable



○ **CIO-07CTP-5NA** - 5 Lead ECG Trunk Cable

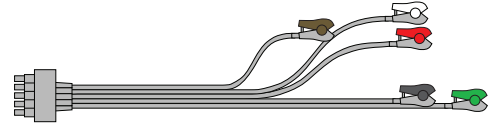

○ **CMO-07FT-5NAB** - 5 Lead ECG Patient Cable

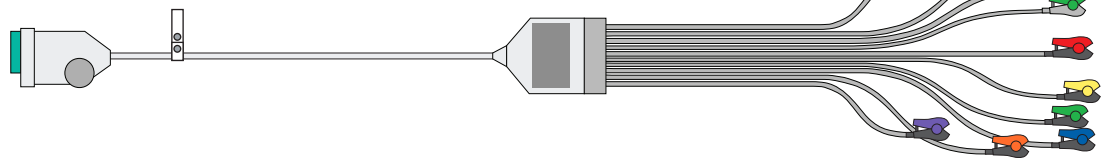

○ **CMO-07FT-10NAB** - 12 Lead ECG Trunk & Patient Cable for 10-electrode

NIBP



DS-8007
Main Unit

**Device with
Serial #
Starting with
5040xxxx**

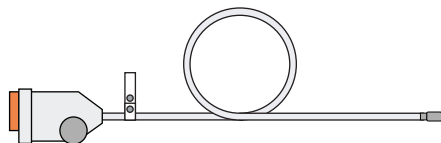

○ **OA-80APR3.5** - 3.5M Cuff Hose

Special Order Item

○ **OA-80APR1.5** - 1.5M Cuff Hose

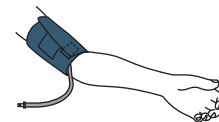

- **98-0600-40** - Infant Cuff (8-13cm)
- **98-0600-41** - Pediatric Cuff (12-19cm)
- **CUF-8503** - Adult Cuff (Small) (17-25cm)
- **CUF-8504** - Adult Cuff (Medium) (23-33cm)
- **CUF-8505** - Adult Cuff (Large) (31-40cm)
- **CUF-8506** - Adult Cuff (Thigh) (38-50cm)
- **CUF-KIT-ADULT** - Adult Cuff Kit (Small, Medium, Large)
- **CUF-KIT-FULL** - Full Cuff Kit (Infant, Pediatric, Small, Medium, Large, Thigh)

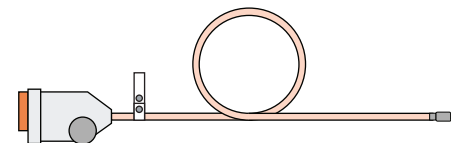

- **OA-80NE1.5** - 1.5M Neonate Cuff Hose
- **OA-80NE3.5** - 3.5M Neonate Cuff Hose

Use with SunTech® Neonatal Soft Disposable BP Cuff

NIBP



DS-8007
Main Unit

Device with
Serial #
Starting with
5041xxxx

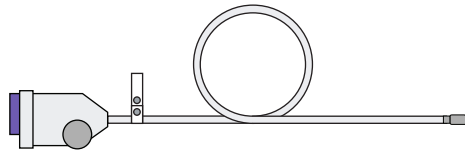

- **OA-80APS3.5-S** - 3.5M Cuff Hose

Special Order Item

- **OA-80APS1.5-S** - 1.5M Cuff Hose

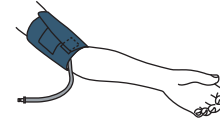

- **98-0600-40** - Infant Cuff (8-13cm)
- **98-0600-41** - Pediatric Cuff (12-19cm)
- **CUF-8503** - Adult Cuff (Small) (17-25cm)
- **CUF-8504** - Adult Cuff (Medium) (23-33cm)
- **CUF-8505** - Adult Cuff (Large) (31-40cm)
- **CUF-8506** - Adult Cuff (Thigh) (38-50cm)
- **CUF-KIT-ADULT** - Adult Cuff Kit (Small, Medium, Large)
- **CUF-KIT-FULL** - Full Cuff Kit (Infant, Pediatric, Small, Medium, Large, Thigh)

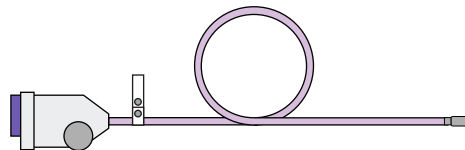

- **OA-80NE1.5-S** - 1.5M Neonate Cuff Hose
- **OA-80NE3.5-S** - 3.5M Neonate Cuff Hose

Use with SunTech® Neonatal Soft Disposable BP Cuff

IBP



DS-8007
Main Unit

*For transducer cables other than the listed below, please contact our Customer Service

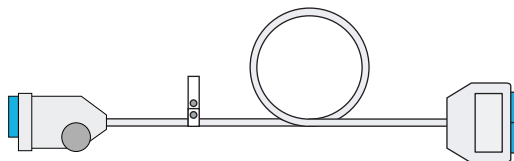

- **CJO-P01B-DJ0.5** - 2ch BP Conversion Cable

**need if 2 IBP cables will be used*



- **CJO-P01B-SB3.6** - 3.6M DTX Plus

Special Order Item

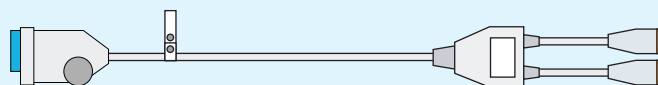

- **CJO-P01B-DB0.8** - 0.8M 2ch DTX Plus
- **CJO-P01B-DB4.3** - 4.3M 2ch DTX Plus

SpO₂

DS-8007N - Nellcor™ Model



DS-8007
Main Unit

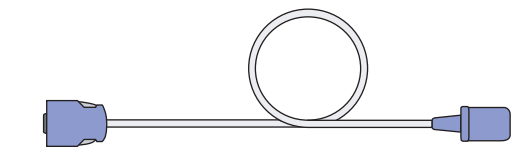

- **1M1120** - Nellcor™ SpO₂ Sensor Extender

***Can only order with Equipment Orders.
Call Nellcor/Medtronic for replacements.**

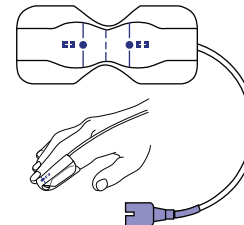

- **OA-MAX-AL** - Nellcor™ Disposable SpO₂

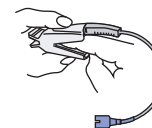

- **OA-DS-100A** - Nellcor™ Durasensor SpO₂

*Contact your local Nellcor/Medtronic Representative for forehead, ankle, child and other disposable sensors

DS-8007M - Masimo® Model

Please contact Masimo® for Accessories

TEMP

**Required for 3, 4, 5 or 6 x TEMP
NOT Required for 1 or 2 x TEMP



DS-8007
Main Unit

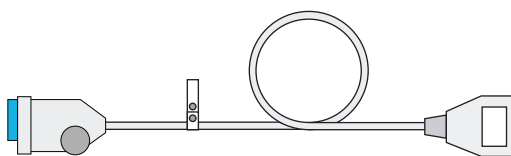

- **CJO-P01T-DA0.5** - 0.5M 2ch Temperature Relay Cable

- **CJO-P01T-DA4.0** - 4.0M 2ch Temperature Relay Cable



- **CS409** - Temperature Probe Surface

CO



DS-8007
Main Unit



○ **CJO-P01C-C2.4** - Catheter Relay Cable



○ **CJO-P01C-T2.4** - Injectate Probe Relay Cable



○ **CJO-P01C-L2.4** - In-line Sensor Relay Cable



○ **CJO-P01C-F2.4** - Flow-through Sensor Relay Cable

EtCO2



DS-8007
Main Unit



○ **HCP-820** Sidestream Unit



*Contact your local Medtronic Representative for sampling tube

○ Covidien Microstream™



○ **HPD-820** Mainstream Unit



*Contact your local Philips Representative

○ PHILIPS RESPIRONICS®

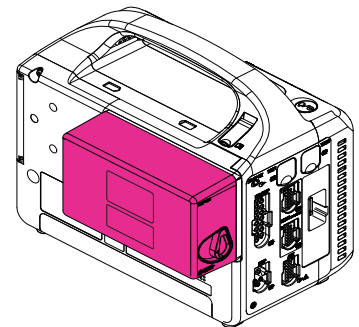

*cannot be used with BIS™ module HBX-800 and OAO-103A

AUX LEM Connection Cable

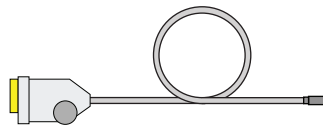

○ **CJO-25TR0.65** (0.65M)

*Use with OAO-103A Mounting Bracket for DS-8007



○ **HCP-810** Sidestream Unit

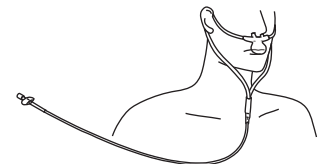

*Contact your local Medtronic Representative for sampling tube

○ Covidien Microstream™

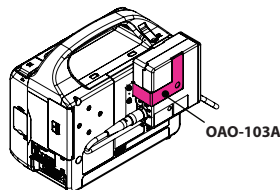

○ **CJO-25TR1.5** (1.5M)

○ **CJO-25TR2.7** (2.7M)



○ **HPD-810** Mainstream Unit



*Contact your local Philips Representative

○ PHILIPS RESPIRONICS®

BIS™



DS-8007
Main Unit

*cannot be used with EtCO2 module HCP-810/HPD-810 and OAO-103A

AUX LEM Connection Cable

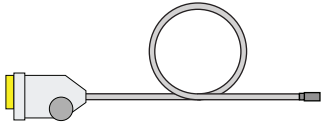

○ **CJO-25TR0.65** (0.65M)
*Use with OAO-103A Mounting Bracket for DS-8007

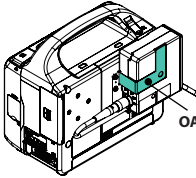

OAO-103A

○ **CJO-25TR1.5** (1.5M)
○ **CJO-25TR2.7** (2.7M)



○ **HBX-800** BISx™ Module Interface



*shown connected to HBX-800 BISx™ Module Interface

○ **186-0195-SF** BISx™ System

Print



DS-8007
Main Unit

Unit Connection Cable (U-LINK)

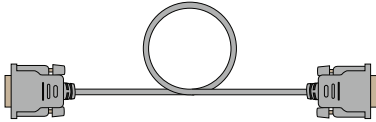

○ **CJO-09SS1.5** (1.5M)

Special Order Item

○ **CJO-09SS0.3** (0.3M)
○ **CJO-09SS5** (5.0M)



○ **DSA-81** AC Unit



○ **HR-800** 3CH Thermal Printer
use with paper OP050-01TDR

*Countertop Recorder Mount OAO-107A is a Special Order Item

Accessories



HLX-801 (600MHz)
HLX-801(G) (1.4GHz)
Telemetry Transmitter Module

*use with DSA-81 AC Unit and OAO-111A HLX Holder Mount



CF-820
Remote Controller



BTO-008
Rechargeable Battery



SD-16G
16GB SD
Full Disclosure Card

*for 240 Hours of Full Disclosure



FSD-8GA
8GB FSD
Full Disclosure Card

*for 120 Hours of Full Disclosure

DS-8400 BEDSIDE MONITOR



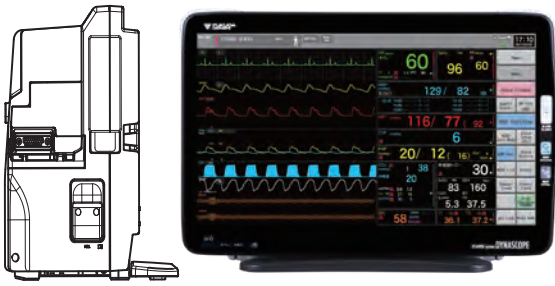

DS-8400

ECG 12-Lead	IBP max. 8ch	NIBP	Optional:	
SpO2 max. 2ch	TEMP max. 6ch	CO	EtCO2	BIS™
			Print	Agent

Configuration

DS-8007 - Portable Bedside Monitor

DSC-8410 - Main Unit



LC-8016TC - 15.6" Display Unit
LC-8018TC - 18.5" Display Unit

Dock on the Back



DS-8007N - Nellcor™ Model
DS-8007M - Masimo® Model

OR

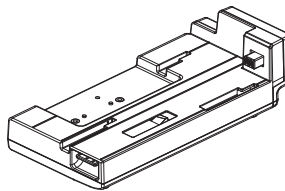

HSA-81 - HS Adapter



HS-8312N - Nellcor™ HS Module
HS-8312M - Masimo® HS Module

Separate Connection

Module Connection Cable
*Connect to Main Unit DSC-8410

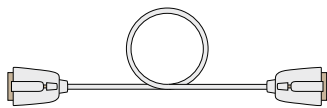

○ **CJO-08SS1.5** (1.5M)



DSA-82
DS-8007 Adapter



DS-8007N
Nellcor™ Model
DS-8007M
Masimo® Model



HSA-80
HS-Adapter



HS-8312N
Nellcor™ HS Module
HS-8312M
Masimo® HS Module

***Can fit one module in the DSC-8410 unit - requires input box for more than one**

Special Order Item

- **CJO-08SS0.3** (0.3M)
- **CJO-08SS3.5** (3.5M)
- **CJO-08SS5** (5M)



IB-8004
Input Box



HG-820
Nellcor™
SpO2 Module



HG-810
Masimo®
SpO2 Module



HM-800
Multi-Module



HP-800
Multi Port
Module



HM-801
Multi-Module

ECG



DS-8007
Main Unit



HS-8312
HS Module



○ **CIO-07CTP-3NA** - 3 Lead ECG Trunk Cable

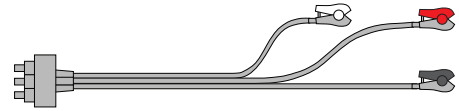

○ **CMO-07FT-3NAB** - 3 Lead ECG Patient Cable



○ **CIO-07CTP-4NA** - 4 Lead ECG Trunk Cable

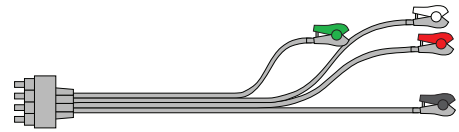

○ **CMO-07FT-4NAB** - 4 Lead ECG Patient Cable



○ **CIO-07CTP-5NA** - 5 Lead ECG Trunk Cable

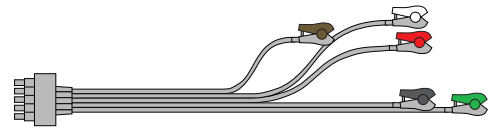

○ **CMO-07FT-5NAB** - 5 Lead ECG Patient Cable

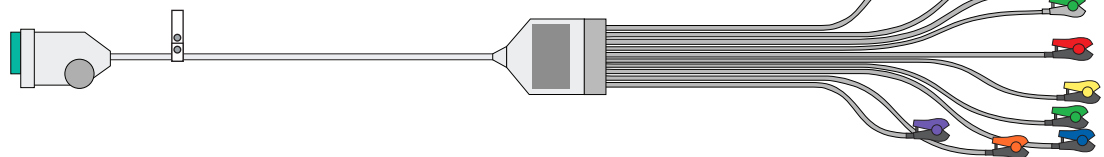

○ **CMO-07FT-10NAB** - 12 Lead ECG Trunk & Patient Cable for 10-electrode

NIBP



DS-8007
Main Unit



HS-8312
HS Module

**Device with
Serial #
Starting with
5040xxxx**

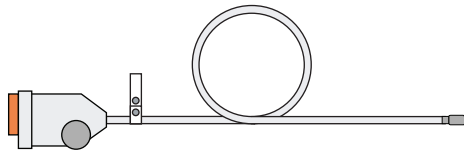

- **OA-80APR3.5** - 3.5M Cuff Hose

Special Order Item

- **OA-80APR1.5** - 1.5M Cuff Hose

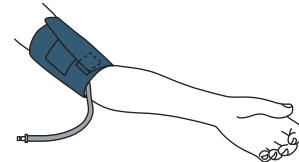

- **98-0600-40** - Infant Cuff (8-13cm)
- **98-0600-41** - Pediatric Cuff (12-19cm)
- **CUF-8503** - Adult Cuff (Small) (17-25cm)
- **CUF-8504** - Adult Cuff (Medium) (23-33cm)
- **CUF-8505** - Adult Cuff (Large) (31-40cm)
- **CUF-8506** - Adult Cuff (Thigh) (38-50cm)
- **CUF-KIT-ADULT** - Adult Cuff Kit (Small, Medium, Large)
- **CUF-KIT-FULL** - Full Cuff Kit (Infant, Pediatric, Small, Medium, Large, Thigh)

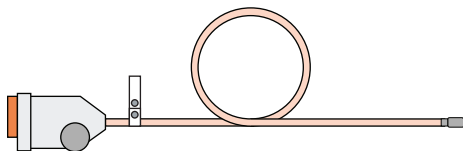

- **OA-80NE1.5** - 1.5M Neonate Cuff Hose
- **OA-80NE3.5** - 3.5M Neonate Cuff Hose

Use with SunTech® Neonatal Soft Disposable BP Cuff

NIBP



DS-8007
Main Unit



HS-8312
HS Module

**Device with
Serial #
Starting with
5041xxxx**

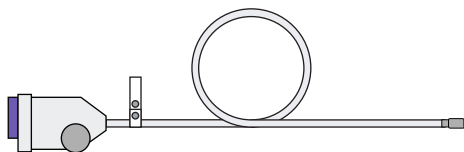

- **OA-80APS3.5-S** - 3.5M Cuff Hose

Special Order Item

- **OA-80APS1.5-S** - 1.5M Cuff Hose

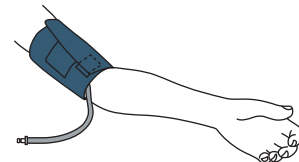

- **98-0600-40** - Infant Cuff (8-13cm)
- **98-0600-41** - Pediatric Cuff (12-19cm)
- **CUF-8503** - Adult Cuff (Small) (17-25cm)
- **CUF-8504** - Adult Cuff (Medium) (23-33cm)
- **CUF-8505** - Adult Cuff (Large) (31-40cm)
- **CUF-8506** - Adult Cuff (Thigh) (38-50cm)
- **CUF-KIT-ADULT** - Adult Cuff Kit (Small, Medium, Large)
- **CUF-KIT-FULL** - Full Cuff Kit (Infant, Pediatric, Small, Medium, Large, Thigh)

Use with SunTech® Neonatal Soft Disposable BP Cuff

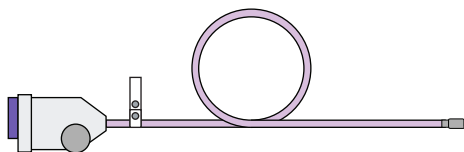

- **OA-80NE1.5-S** - 1.5M Neonate Cuff Hose
- **OA-80NE3.5-S** - 3.5M Neonate Cuff Hose

IBP



DS-8007
Main Unit



HS-8312
HS Module



HM-800
Multi-Module



HM-801
Multi-Module

***For transducer cables other than the listed below, please contact our Customer Service**

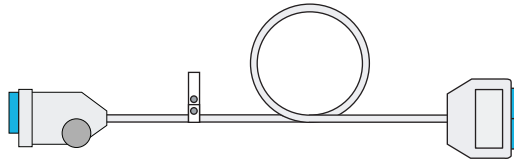

○ **CJO-P01B-DJ0.5** - 2ch BP Conversion Cable

**need if 2 IBP cables will be used*



○ **CJO-P01B-SB3.6** - 3.6M DTX Plus

Special Order Item

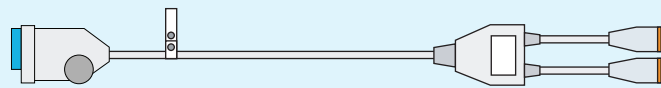

○ **CJO-P01B-DB0.8** - 0.8M 2ch DTX Plus

○ **CJO-P01B-DB4.3** - 4.3M 2ch DTX Plus

SpO2



DS-8007
Main Unit



HG-820
Nellcor™ SpO2 Module



HG-810
Masimo® SpO2 Module

DS-8007N or HG-820 - Nellcor™ Model

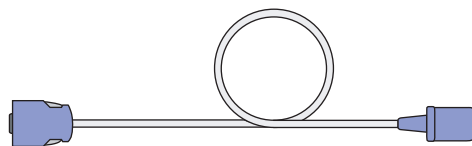

○ **1M1120** - Nellcor™ SpO2 Sensor Extender

***Can only order with Equipment Orders.
Call Nellcor/Medtronic for replacements.**

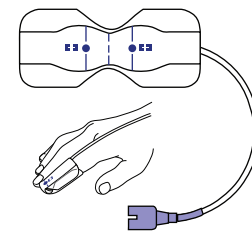

○ **OA-MAX-AL** - Nellcor™ Disposable SpO2

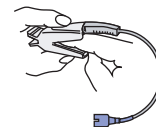

○ **OA-DS-100A** - Nellcor™ Durasensor SpO2

**Contact your local Nellcor/Medtronic Representative for forehead, ankle, child and other disposable sensors*

DS-8007M or HG-810 - Masimo® Model

Please contact Masimo® for Accessories

TEMP



DS-8007
Main Unit



HS-8312
HS Module



HM-800
Multi-Module



HM-801
Multi-Module

*Required to measure TEMP with HS-8312, HM-800 and HM-801

*NOT Required for 1 or 2 x TEMP with DS-8007

*Required for 3, 4, 5 or 6 x TEMP with DS-8007

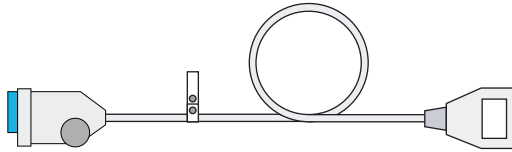

○ **CJO-P01T-DA0.5** - 0.5M 2ch Temperature Relay Cable

○ **CJO-P01T-DA4.0** - 4.0M 2ch Temperature Relay Cable



○ **CS409** - Temperature Probe Surface

CO



DS-8007
Main Unit



HS-8312
HS Module



HM-800
Multi-Module



HM-801
Multi-Module



○ **CJO-P01C-C2.4** - Catheter Relay Cable



○ **CJO-P01C-T2.4** - Injectate Probe Relay Cable



○ **CJO-P01C-L2.4** - In-line Sensor Relay Cable



○ **CJO-P01C-F2.4** - Flow-through Sensor Relay Cable

EtCO₂



HS-8312
HS Module

AUX Connection Cable



- CJO-15RR0.17G** (0.17M)
- CJO-15RR0.65G** (0.65M)
- CJO-15RR1.5G** (1.5M)

Special Order Item

- CJO-15RR3G** (3M)



- HCP-810** Sidestream Unit

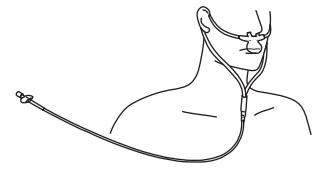

- Covidien Microstream™

*Contact your local Medtronic Representative for sampling tube



- HPD-810** Mainstream Unit



- PHILIPS RESPIRONICS®

*Contact your local Philips Representative



- HCP-820** Sidestream Unit



- Covidien Microstream™

*Contact your local Medtronic Representative for sampling tube



- HPD-820** Mainstream Unit



- PHILIPS RESPIRONICS®

*Contact your local Philips Representative

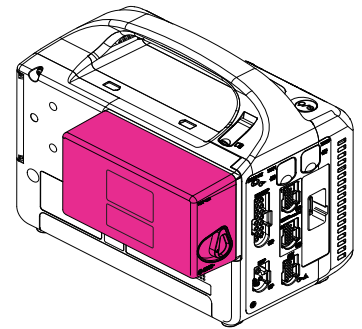

DS-8007 Main Unit

*cannot be used with BIS™ module HBX-800 and OAO-103A

AUX LEM Connection Cable



- CJO-25TR0.65** (0.65M)

*Use with OAO-103A Mounting Bracket for DS-8007

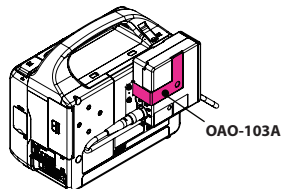

- CJO-25TR1.5** (1.5M)
- CJO-25TR2.7** (2.7M)



- HCP-810** Sidestream Unit

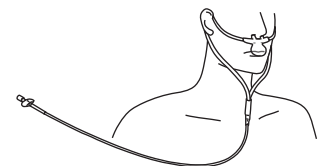

- Covidien Microstream™

*Contact your local Medtronic Representative for sampling tube



- HPD-810** Mainstream Unit



- PHILIPS RESPIRONICS®

*Contact your local Philips Representative

BIS™



HM-801
Multi-Module

AUX LEM Connection Cable

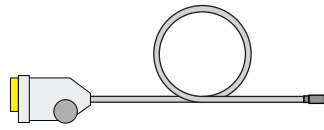

- **CJO-25TR0.65** (0.65M)
- **CJO-25TR1.5** (1.5M)
- **CJO-25TR2.7** (2.7M)



○ **HBX-800 BISx™ Module Interface**



*shown connected to HBX-800 BISx™ Module Interface

○ **186-0195-SF BISx™ System**

*cannot be used with EtCO2 module HCP-810/HPD-810 and OAO-103A

AUX LEM Connection Cable

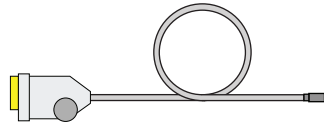

- **CJO-25TR0.65** (0.65M)
- *Use with OAO-103A Mounting Bracket for DS-8007

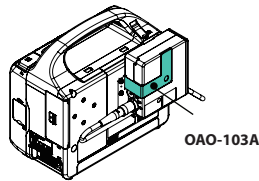

○ **HBX-800 BISx™ Module Interface**



*shown connected to HBX-800 BISx™ Module Interface

○ **186-0195-SF BISx™ System**



DS-8007 Main Unit

- **CJO-25TR1.5** (1.5M)
- **CJO-25TR2.7** (2.7M)



HS-8312
HS Module

AUX Connection Cable

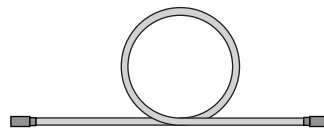

- **CJO-15RR0.17G** (0.17M)
- **CJO-15RR0.65G** (0.65M)
- **CJO-15RR1.5G** (1.5M)

Special Order Item

- **CJO-15RR3G** (3M)



○ **HBX-800 BISx™ Module Interface**



*shown connected to HBX-800 BISx™ Module Interface

○ **186-0195-SF BISx™ System**

Print



DS-8400

***The HR-800 can also be built in directly into the DSC-8410**

Unit Connection Cable (U-LINK)

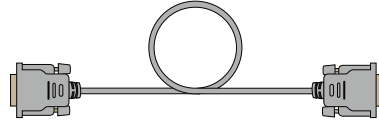

○ **CJO-09SS1.5** (1.5M)

Special Order Item

- **CJO-09SS0.3** (0.3M)
- **CJO-09SS5** (5.0M)



○ **HR-800** 3CH Thermal Printer
use with paper OP050-01TDR

Agent



DS-8400

Unit Connection Cable (U-LINK)

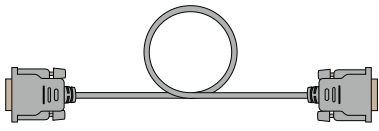

○ **CJO-09SS1.5** (1.5M)

Special Order Item

- **CJO-09SS0.3** (0.3M)
- **CJO-09SS5** (5.0M)



○ **MGU-801P** AGO2 Gas Unit

*Contact your local Mindray Representative for Water Trap and Sampling Tube

Accessories



HLX-801 (600MHz)
HLX-801(G) (1.4GHz)
Telemetry Transmitter
Module



CF-820
Remote Controller



BTO-005
Rechargeable Battery



FCS-64G
64GB CFast
Full Disclosure Card
*for 240 Hours of Full Disclosure



FCF-128
(1Z7333B)
128MB CF Card
Flash Memory Card
*for Data Transfer

DS-8100 PORTABLE BEDSIDE MONITOR



DS-8100 system DYNASCOPE



DS-8100N - Nellcor™ Model
DS-8100M - Masimo® Model

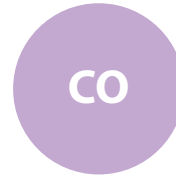

Optional:



ECG

DS-8100
Main Unit

CIO-07CTP-3NA - 3 Lead ECG Trunk Cable	<input type="radio"/> CMO-07FT-3NAB - 3 Lead ECG Patient Cable
CIO-07CTP-4NA - 4 Lead ECG Trunk Cable	<input type="radio"/> CMO-07FT-4NAB - 4 Lead ECG Patient Cable
CIO-07CTP-5NA - 5 Lead ECG Trunk Cable	<input type="radio"/> CMO-07FT-5NAB - 5 Lead ECG Patient Cable

NIBP

DS-8100
Main Unit

Device with
Serial #
Starting with
5040xxxx

<input type="radio"/> OA-80APR3.5 - 3.5M Cuff Hose	<input type="radio"/> 98-0600-40 - Infant Cuff (8-13cm)
<input type="radio"/> OA-80APR1.5 - 1.5M Cuff Hose	<input type="radio"/> 98-0600-41 - Pediatric Cuff (12-19cm)
Special Order Item	<input type="radio"/> CUF-8503 - Adult Cuff (Small) (17-25cm)
	<input type="radio"/> CUF-8504 - Adult Cuff (Medium) (23-33cm)
	<input type="radio"/> CUF-8505 - Adult Cuff (Large) (31-40cm)
	<input type="radio"/> CUF-8506 - Adult Cuff (Thigh) (38-50cm)
	<input type="radio"/> CUF-KIT-ADULT - Adult Cuff Kit (Small, Medium, Large)
	<input type="radio"/> CUF-KIT-FULL - Full Cuff Kit (Infant, Pediatric, Small, Medium, Large, Thigh)
<input type="radio"/> OA-80ONE1.5 - 1.5M Neonate Cuff Hose	
<input type="radio"/> OA-80ONE3.5 - 3.5M Neonate Cuff Hose	

Use with SunTech® Neonatal Soft Disposable BP Cuff

NIBP



DS-8100
Main Unit

Device with
Serial #
Starting with
5041xxxx

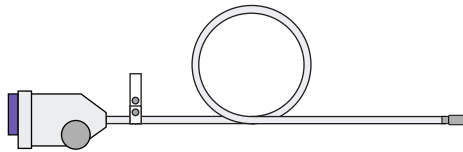

- **OA-80APS3.5-S** - 3.5M Cuff Hose

Special Order Item

- **OA-80APS1.5-S** - 1.5M Cuff Hose

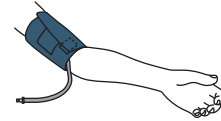

- **98-0600-40** - Infant Cuff (8-13cm)
- **98-0600-41** - Pediatric Cuff (12-19cm)
- **CUF-8503** - Adult Cuff (Small) (17-25cm)
- **CUF-8504** - Adult Cuff (Medium) (23-33cm)
- **CUF-8505** - Adult Cuff (Large) (31-40cm)
- **CUF-8506** - Adult Cuff (Thigh) (38-50cm)
- **CUF-KIT-ADULT** - Adult Cuff Kit (Small, Medium, Large)
- **CUF-KIT-FULL** - Full Cuff Kit (Infant, Pediatric, Small, Medium, Large, Thigh)

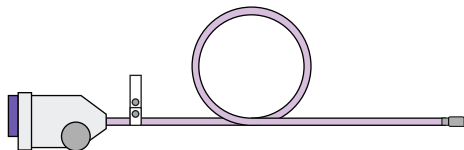

- **OA-80NE1.5-S** - 1.5M Neonate Cuff Hose
- **OA-80NE3.5-S** - 3.5M Neonate Cuff Hose

Use with SunTech® Neonatal Soft Disposable BP Cuff

IBP



DS-8100
Main Unit

*For transducer cables other than the listed below, please contact our Customer Service

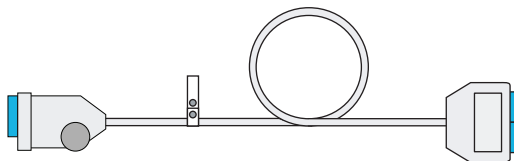

- **CJO-P01B-DJ0.5** - 2ch BP Conversion Cable

**need if 2 IBP cables will be used*



- **CJO-P01B-SB3.6** - 3.6M DTX Plus

Special Order Item

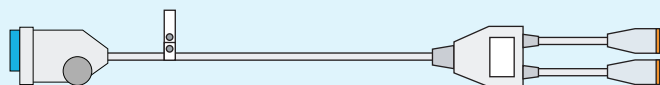

- **CJO-P01B-DB0.8** - 0.8M 2ch DTX Plus
- **CJO-P01B-DB4.3** - 4.3M 2ch DTX Plus

SpO₂



DS-8100
Main Unit

DS-8100N - Nellcor™ Model

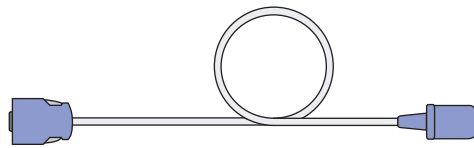

- **1M1120** - Nellcor™ SpO₂ Sensor Extender

*Contact your local Nellcor/Medtronic Representative for forehead, ankle, child and other disposable sensors

***Can only order with Equipment Orders.
Call Nellcor/Medtronic for replacements.**

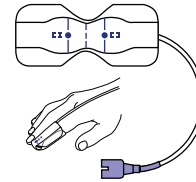

- **OA-MAX-AL** - Nellcor™ Disposable SpO₂

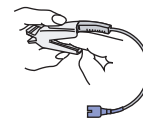

- **OA-DS-100A** - Nellcor™ Durasensor SpO₂

DS-8007M - Masimo® Model

Please contact Masimo® for Accessories

TEMP



DS-8100
Main Unit

**Required for 3 or 4 x TEMP*

**NOT Required for 1 or 2 x TEMP*

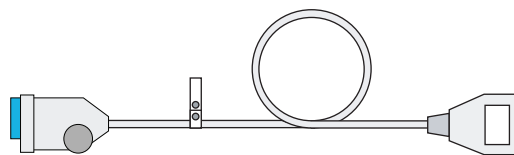

- **CJO-P01T-DA0.5** - 0.5M 2ch Temperature Relay Cable

- **CJO-P01T-DA4.0** - 4.0M 2ch Temperature Relay Cable



- **CS409** - Temperature Probe Surface

CO



DS-8100
Main Unit



- **CJO-P01C-C2.4** - Catheter Relay Cable



- **CJO-P01C-T2.4** - Injectate Probe Relay Cable



- **CJO-P01C-L2.4** - In-line Sensor Relay Cable



- **CJO-P01C-F2.4** - Flow-through Sensor Relay Cable

EtCO₂



DS-8100 Main Unit

AUX Connection Cable

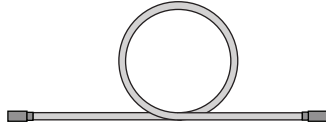

○ **CJO-15RR0.17G** (0.17M)

*Use with OAO-86A HCP Fixing Bracket for DS-8100

OAO-86A

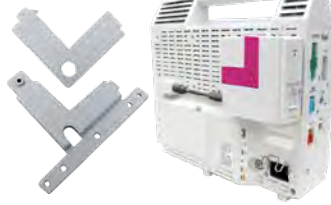

○ **CJO-15RR0.65G** (0.65M)

○ **CJO-15RR1.5G** (1.5M)

Special Order Item

○ **CJO-15RR3G** (3M)



○ **HCP-810** Sidestream Unit

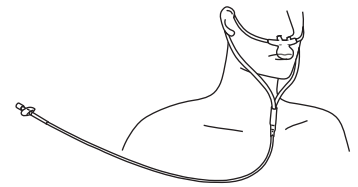

*Contact your local Medtronic Representative for sampling tube

○ Covidien Microstream™



○ **HPD-810** Mainstream Unit



*Contact your local Philips Representative

○ PHILIPS RESPIRONICS®

Print



DS-8100 Main Unit



○ **HR-811** Printer/ Expansion Port Unit
Slave Monitor Output/Analog Output
use with paper OP050-01TDR

Accessories



HLX-801 (600MHz)
HLX-801(G) (1.4GHz)
Telemetry Transmitter Module



CF-820
Remote Controller



BTO-008
Rechargeable Battery



FCF-16GA
(9B0102420)
16GB Full Disclosure Card
*for 48 Hours of Full Disclosure



SD-8G
8GB SD Card
*to store patient data



SD-1G
1GB SD Card
*to store patient data



FCF-128
(1Z7333B)
128MB CF Card
Flash Memory Card
*for transferring monitor settings

DS-8200 TRANSPORT MONITOR





DS-8200

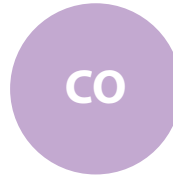

Optional:



Configuration



LC-8210
Display Unit



BS-8210
Base Unit



HS-8312N - Nellcor™ HS Module
HS-8312M - Masimo® HS Module



HSB-80
HS Adapter

ECG



DS-8200
(HS-8312 HS Module)



○ **CIO-07CTP-3NA** - 3 Lead ECG Trunk Cable

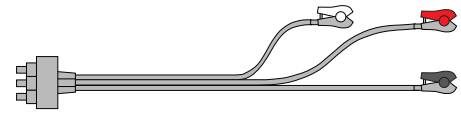

○ **CMO-07FT-3NAB** - 3 Lead ECG Patient Cable



○ **CIO-07CTP-4NA** - 4 Lead ECG Trunk Cable

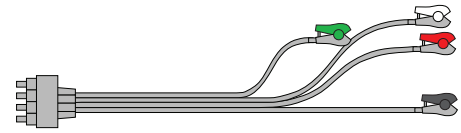

○ **CMO-07FT-4NAB** - 4 Lead ECG Patient Cable



○ **CIO-07CTP-5NA** - 5 Lead ECG Trunk Cable

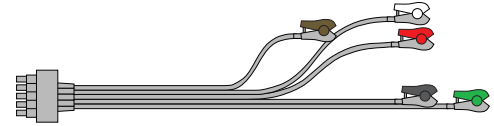

○ **CMO-07FT-5NAB** - 5 Lead ECG Patient Cable

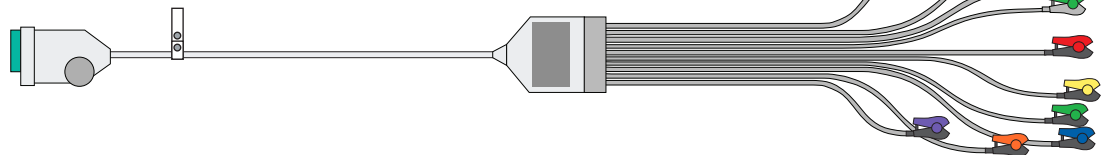

○ **CMO-07FT-10NAB** - 12 Lead ECG Trunk & Patient Cable for 10-electrode

NIBP



DS-8200
(HS-8312 HS Module)

**Device with
Serial #
Starting with
5040xxxx**

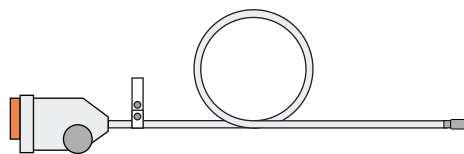

○ **OA-80APR3.5** - 3.5M Cuff Hose

Special Order Item

○ **OA-80APR1.5** - 1.5M Cuff Hose

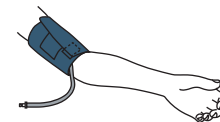

- **98-0600-40** - Infant Cuff (8-13cm)
- **98-0600-41** - Pediatric Cuff (12-19cm)
- **CUF-8503** - Adult Cuff (Small) (17-25cm)
- **CUF-8504** - Adult Cuff (Medium) (23-33cm)
- **CUF-8505** - Adult Cuff (Large) (31-40cm)
- **CUF-8506** - Adult Cuff (Thigh) (38-50cm)
- **CUF-KIT-ADULT** - Adult Cuff Kit (Small, Medium, Large)
- **CUF-KIT-FULL** - Full Cuff Kit (Infant, Pediatric, Small, Medium, Large, Thigh)

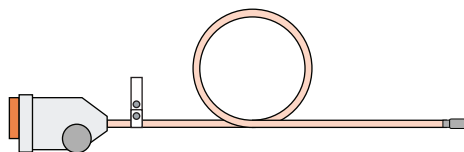

- **OA-80NE1.5** - 1.5M Neonate Cuff Hose
- **OA-80NE3.5** - 3.5M Neonate Cuff Hose

Use with SunTech® Neonatal Soft Disposable BP Cuff

NIBP



DS-8200
(HS-8312 HS Module)

Device with
Serial #
Starting with
5041xxxx

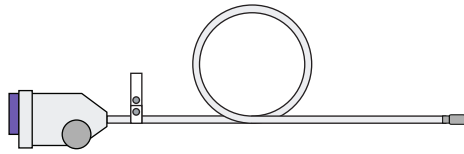

- **OA-80APS3.5-S** - 3.5M Cuff Hose

Special Order Item

- **OA-80APS1.5-S** - 1.5M Cuff Hose

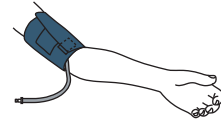

- **98-0600-40** - Infant Cuff (8-13cm)
- **98-0600-41** - Pediatric Cuff (12-19cm)
- **CUF-8503** - Adult Cuff (Small) (17-25cm)
- **CUF-8504** - Adult Cuff (Medium) (23-33cm)
- **CUF-8505** - Adult Cuff (Large) (31-40cm)
- **CUF-8506** - Adult Cuff (Thigh) (38-50cm)
- **CUF-KIT-ADULT** - Adult Cuff Kit (Small, Medium, Large)
- **CUF-KIT-FULL** - Full Cuff Kit (Infant, Pediatric, Small, Medium, Large, Thigh)

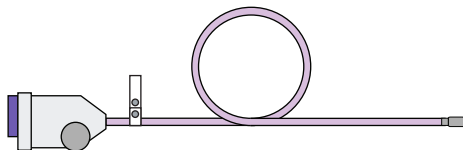

- **OA-80NE1.5-S** - 1.5M Neonate Cuff Hose
- **OA-80NE3.5-S** - 3.5M Neonate Cuff Hose

Use with SunTech® Neonatal Soft Disposable BP Cuff

IBP



DS-8200
(HS-8312 HS Module)

*For transducer cables other than the listed below, please contact our Customer Service

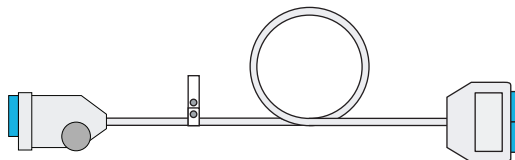

- **CJO-P01B-DJ0.5** - 2ch BP Conversion Cable

**need if 2 IBP cables will be used*



- **CJO-P01B-SB3.6** - 3.6M DTX Plus

Special Order Item

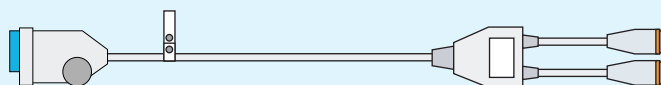

- **CJO-P01B-DB0.8** - 0.8M 2ch DTX Plus
- **CJO-P01B-DB4.3** - 4.3M 2ch DTX Plus

SpO2

HM-8312N - Nellcor™ Model

***Can only order with Equipment Orders.
Call Nellcor/Medtronic for replacements.**



DS-8200
(HS-8312 HS Module)

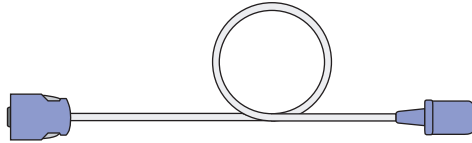

- **1M1120** - Nellcor™ SpO2 Sensor Extender

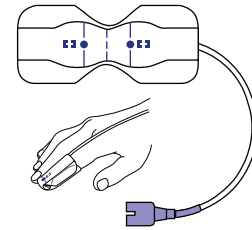

- **OA-MAX-AL** - Nellcor™ Disposable SpO2

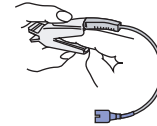

- **OA-DS-100A** - Nellcor™ Durasensor SpO2

*Contact your local Nellcor/Medtronic Representative for forehead, ankle, child and other disposable sensors

DS-8007M - Masimo® Model

Please contact Masimo® for Accessories

TEMP



DS-8200
(HS-8312 HS Module)

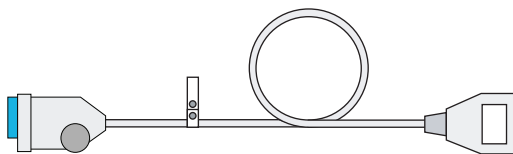

- **CJO-P01T-DA0.5** - 0.5M 2ch Temperature Relay Cable

- **CJO-P01T-DA4.0** - 4.0M 2ch Temperature Relay Cable



- **CS409** - Temperature Probe Surface

CO



DS-8200
(HS-8312 HS Module)



○ **CJO-P01C-C2.4** - Catheter Relay Cable



○ **CJO-P01C-T2.4** - Injectate Probe Relay Cable



○ **CJO-P01C-L2.4** - In-line Sensor Relay Cable



○ **CJO-P01C-F2.4** - Flow-through Sensor Relay Cable

EtCO2



DS-8200
(HS-8312 HS Module)

AUX Connection Cable

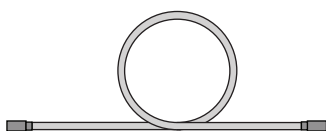

○ **CJO-15RR0.65G** (0.65M)

○ **CJO-15RR1.5G** (1.5M)

Special Order Item

○ **CJO-15RR3G** (3M)



○ **HCP-810** Sidestream Unit

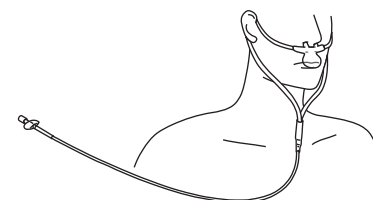

*Contact your local Medtronic Representative for sampling tube

○ **Covidien Microstream™**



○ **HPD-810** Mainstream Unit



*Contact your local Philips Representative

○ **PHILIPS RESPIRONICS®**

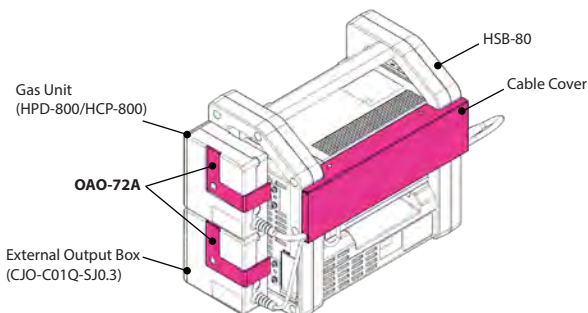

OAO-72A - Gas Unit/External Output Mounting Bracket

*2 brackets per package

Print



DS-8200

Unit Connection Cable (U-LINK)

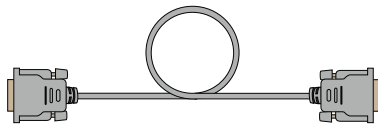

○ **CJO-09SS1.5** (1.5M)

Special Order Item

- **CJO-09SS0.3** (0.3M)
- **CJO-09SS5** (5.0M)



○ **HR-800** 3CH Thermal Printer
use with paper OP050-01TDR

Accessories



HLX-801 (600MHz)
HLX-801(G) (1.4GHz)
Telemetry Transmitter
Module

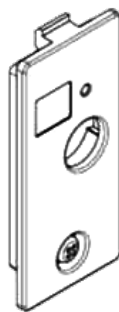

OAT-02A
Installation Cover



CF-820
Remote Controller



BTO-008
Rechargeable Battery

*MAX 2 x BTO-008 supported for 5 hour battery power operation
- 1 x BTO-008 for HSB-80 and 1 x BTO-008 for BS-8210



FCF-16GA
(9B0102420)
16GB Full Disclosure Card

*for 48 Hours of Full Disclosure



FCF-128
(1Z7333B)
128MB CF Card
Flash Memory Card

*for transferring monitor settings



SD-8G
8GB SD Card

*to store patient data



SD-1G
1GB SD Card

*to store patient data

DS-8500 BEDSIDE MONITOR



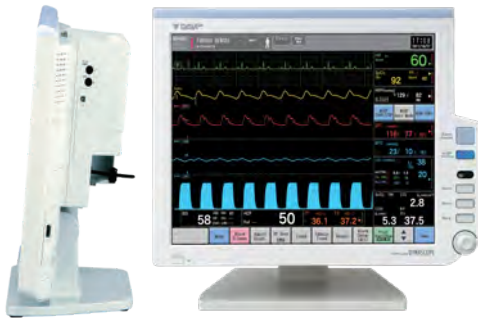

DS-8500



ECG
12-Lead



IBP
max. 8ch



NIBP



SpO2
max. 2ch



TEMP
max. 8ch

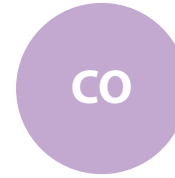

CO

Optional:



EtCO2



BIS™



Print



Agent

Configuration



LC-8015TC - 15" Display Unit
LC-8019TC - 19" Display Unit



DSC-8530 - Main Unit

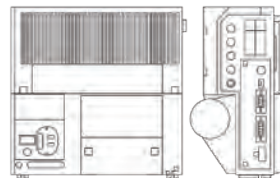

OAO-44A - Stand
(optional)

Module Connection Cable

*Connect to Main Unit DSC-8530

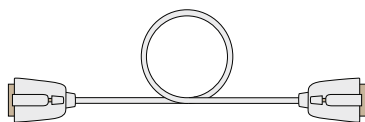

○ **CJO-08SS1.5** (1.5M)



DSA-82
DS-8007 Adapter



DS-8007N
Nellcor™ Model
DS-8007M
Masimo® Model



HSA-80
HS- Adapter



HS-8312N
Nellcor™ HS Module
HS-8312M
Masimo® HS Module

Special Order Item

- **CJO-08SS0.3** (0.3M)
- **CJO-08SS3.5** (3.5M)
- **CJO-08SS5** (5M)



IB-8004
Input Box



HG-820
Nellcor™
SpO2 Module



HG-810
Masimo®
SpO2 Module



HM-800
Multi-Module



HP-800
Multi Port
Module



HM-801
Multi-Module

ECG



DS-8007
Main Unit



HS-8312
HS Module



○ **CIO-07CTP-3NA** - 3 Lead ECG Trunk Cable

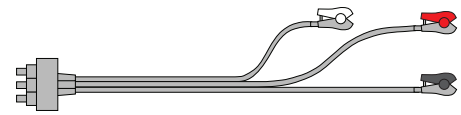

○ **CMO-07FT-3NAB** - 3 Lead ECG Patient Cable



○ **CIO-07CTP-4NA** - 4 Lead ECG Trunk Cable

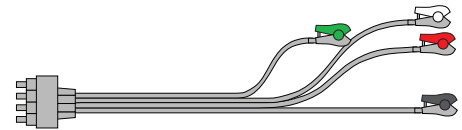

○ **CMO-07FT-4NAB** - 4 Lead ECG Patient Cable



○ **CIO-07CTP-5NA** - 5 Lead ECG Trunk Cable

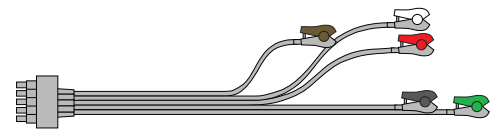

○ **CMO-07FT-5NAB** - 5 Lead ECG Patient Cable



○ **CMO-07FT-10NAB** - 12 Lead ECG Trunk & Patient Cable for 10-electrode

NIBP



DS-8007
Main Unit



HS-8312
HS Module

**Device with
Serial #
Starting with
5040xxxx**

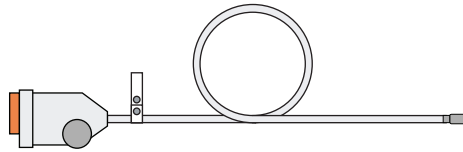

- **OA-80APR3.5** - 3.5M Cuff Hose

Special Order Item

- **OA-80APR1.5** - 1.5M Cuff Hose

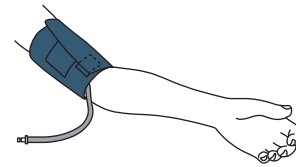

- **98-0600-40** - Infant Cuff (8-13cm)
- **98-0600-41** - Pediatric Cuff (12-19cm)
- **CUF-8503** - Adult Cuff (Small) (17-25cm)
- **CUF-8504** - Adult Cuff (Medium) (23-33cm)
- **CUF-8505** - Adult Cuff (Large) (31-40cm)
- **CUF-8506** - Adult Cuff (Thigh) (38-50cm)
- **CUF-KIT-ADULT** - Adult Cuff Kit (Small, Medium, Large)
- **CUF-KIT-FULL** - Full Cuff Kit (Infant, Pediatric, Small, Medium, Large, Thigh)

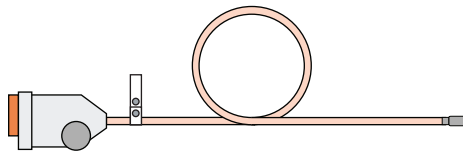

- **OA-80NE1.5** - 1.5M Neonate Cuff Hose
- **OA-80NE3.5** - 3.5M Neonate Cuff Hose

Use with SunTech® Neonatal Soft Disposable BP Cuff

NIBP



DS-8007
Main Unit



HS-8312
HS Module

**Device with
Serial #
Starting with
5041xxxx**

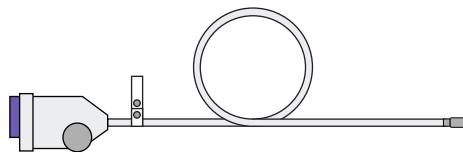

- **OA-80APS3.5-S** - 3.5M Cuff Hose

Special Order Item

- **OA-80APS1.5-S** - 1.5M Cuff Hose

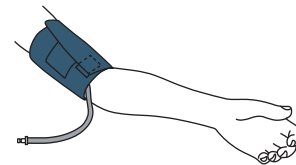

- **98-0600-40** - Infant Cuff (8-13cm)
- **98-0600-41** - Pediatric Cuff (12-19cm)
- **CUF-8503** - Adult Cuff (Small) (17-25cm)
- **CUF-8504** - Adult Cuff (Medium) (23-33cm)
- **CUF-8505** - Adult Cuff (Large) (31-40cm)
- **CUF-8506** - Adult Cuff (Thigh) (38-50cm)
- **CUF-KIT-ADULT** - Adult Cuff Kit (Small, Medium, Large)
- **CUF-KIT-FULL** - Full Cuff Kit (Infant, Pediatric, Small, Medium, Large, Thigh)

Use with SunTech® Neonatal Soft Disposable BP Cuff

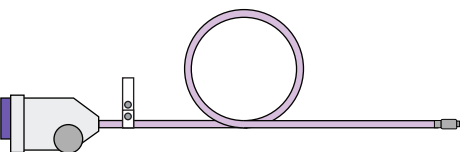

- **OA-80NE1.5-S** - 1.5M Neonate Cuff Hose
- **OA-80NE3.5-S** - 3.5M Neonate Cuff Hose

IBP

***For transducer cables other than the listed below, please contact our Customer Service**



DS-8007
Main Unit



HS-8312
HS Module



HM-800
Multi-Module



HM-801
Multi-Module

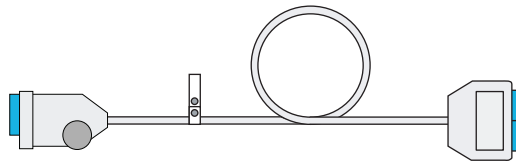

○ **CJO-P01B-DJ0.5** - 2ch BP Conversion Cable

**need if 2 IBP cables will be used*



○ **CJO-P01B-SB3.6** - 3.6M DTX Plus

Special Order Item

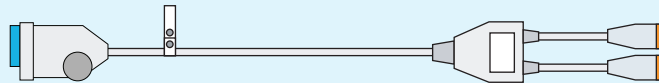

○ **CJO-P01B-DB0.8** - 0.8M 2ch DTX Plus

○ **CJO-P01B-DB4.3** - 4.3M 2ch DTX Plus

SpO2

DS-8007N, HM-8312N or HG-820 - Nellcor™ Model



DS-8007
Main Unit



HS-8312
HS Module



HG-820
Nellcor™ SpO2 Module



HG-810
Masimo® SpO2 Module

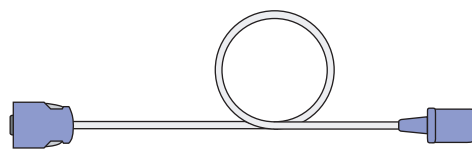

○ **1M1120** - Nellcor™ SpO2 Sensor Extender

***Can only order with Equipment Orders.
Call Nellcor/Medtronic for replacements.**

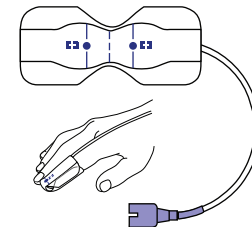

○ **OA-MAX-AL** - Nellcor™ Disposable SpO2

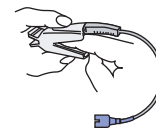

○ **OA-DS-100A** - Nellcor™ Durasensor SpO2

**Contact your local Nellcor/Medtronic Representative for forehead, ankle, child and other disposable sensors*

DS-8007M, HM-8312M or HG-810 - Masimo® Model

Please contact Masimo® for Accessories

TEMP



DS-8007
Main Unit



HS-8312
HS Module



HM-800
Multi-Module



HM-801
Multi-Module

**Required for 3, 4, 5 or 6 x TEMP*

**Required to measure TEMP with HS-8312 or HM-800*

**NOT Required to measure 1 or 2 X TEMP with DS-8007*

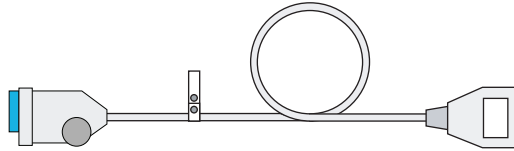

○ **CJO-P01T-DA0.5** - 0.5M 2ch Temperature Relay Cable

○ **CJO-P01T-DA4.0** - 4.0M 2ch Temperature Relay Cable



○ **CS409** - Temperature Probe Surface

CO



DS-8007
Main Unit



HS-8312
HS Module



HM-800
Multi-Module



HM-801
Multi-Module



○ **CJO-P01C-C2.4** - Catheter Relay Cable



○ **CJO-P01C-T2.4** - Injectate Probe Relay Cable



○ **CJO-P01C-L2.4** - In-line Sensor Relay Cable



○ **CJO-P01C-F2.4** - Flow-through Sensor Relay Cable

EtCO₂



HS-8312
HS Module

AUX Connection Cable

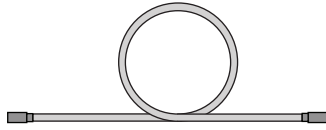

- **CJO-15RR0.65G** (0.65M)
- **CJO-15RR1.5G** (1.5M)

Special Order Item

- **CJO-15RR3G** (3M)



- **HCP-810** Sidestream Unit

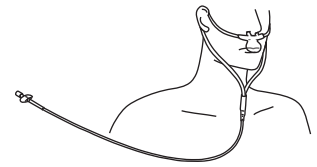

*Contact your local Medtronic Representative for sampling tube

- Covidien Microstream™



- **HPD-810** Mainstream Unit



*Contact your local Philips Representative

- PHILIPS RESPIRONICS®



- **HCP-820** Sidestream Unit



*Contact your local Medtronic Representative for sampling tube

- Covidien Microstream™



- **HPD-820** Mainstream Unit



*Contact your local Philips Representative

- PHILIPS RESPIRONICS®

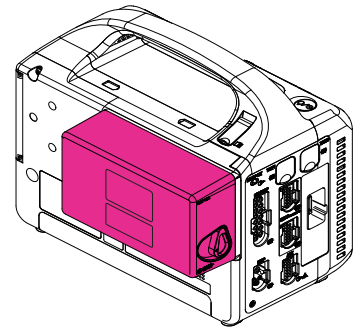

DS-8007 Main Unit

*cannot be used with BIST™ module HBX-800 and OAO-103A

AUX LEM Connection Cable



- **CJO-25TR0.65** (0.65M)

*Use with OAO-103A Mounting Bracket for DS-8007

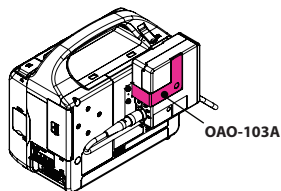

- **CJO-25TR1.5** (1.5M)
- **CJO-25TR2.7** (2.7M)



- **HCP-810** Sidestream Unit

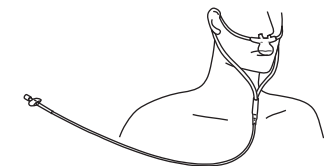

*Contact your local Medtronic Representative for sampling tube

- Covidien Microstream™



- **HPD-810** Mainstream Unit



*Contact your local Philips Representative

- PHILIPS RESPIRONICS®

BIS™



HM-801
Multi-Module

AUX LEM Connection Cable

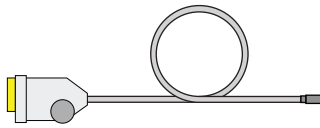

- CJO-25TR0.65 (0.65M)
- CJO-25TR1.5 (1.5M)
- CJO-25TR2.7 (2.7M)



○ HBX-800 BISx™ Module Interface



*shown connected to HBX-800 BISx™ Module Interface
○ 186-0195-SF BISx™ System



DS-8007 Main Unit

**cannot be used with EtCO2 module HCP-810/HPD-810 and OAO-103A*

AUX LEM Connection Cable

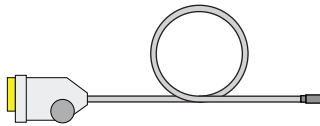

- CJO-25TR0.65 (0.65M)
- *Use with OAO-103A Mounting Bracket for DS-8007*

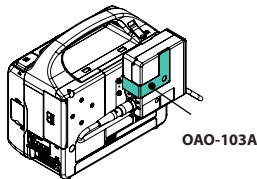

- CJO-25TR1.5 (1.5M)
- CJO-25TR2.7 (2.7M)



○ HBX-800 BISx™ Module Interface



*shown connected to HBX-800 BISx™ Module Interface
○ 186-0195-SF BISx™ System



HS-8312
HS Module

AUX Connection Cable



- CJO-15RR0.17G (0.17M)
- CJO-15RR0.65G (0.65M)
- CJO-15RR1.5G (1.5M)

Special Order Item
○ CJO-15RR3G (3M)



○ HBX-800 BISx™ Module Interface



*shown connected to HBX-800 BISx™ Module Interface
○ 186-0195-SF BISx™ System

Print



DS-8500

Unit Connection Cable (U-LINK)

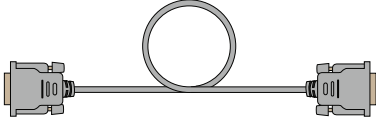

- CJO-09SS1.5 (1.5M)

Special Order Item

- CJO-09SS0.3 (0.3M)
- CJO-09SS5 (5.0M)



- **HR-800** 3CH Thermal Printer
use with paper OP050-01TDR

Generic Ethernet Cable

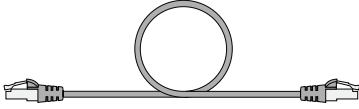



- **HP** Network Printer

Agent



DS-8500

Unit Connection Cable (U-LINK)

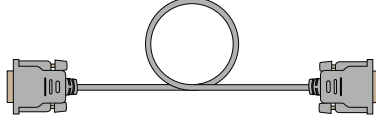

- CJO-09SS1.5 (1.5M)

Special Order Item

- CJO-09SS0.3 (0.3M)
- CJO-09SS5 (5.0M)



- **MGU-801P** AGO2 Gas Unit

*Contact your local Mindray Representative for Water Trap and Sampling Tube

Accessories



HLX-801 (600MHz)
Telemetry Transmitter
Module

Special Order Item



OAT-8185A
Mounting Bracket



CF-820
Remote Controller



FCF-16GA
(9B0102420)
16GB Full Disclosure Card

*for 48 Hours of Full Disclosure



SD-8G
8GB SD Card

*to store patient data



SD-1G
1GB SD Card

*to store patient data



FCF-128
(1Z7333B)
128MB CF Card
Flash Memory Card

*for transferring monitor settings

DS-8900 CENTRAL STATION





DS-8900 - Central Station Main Unit



LC-8026T - External Display

Print

Unit Connection Cable (U-LINK)

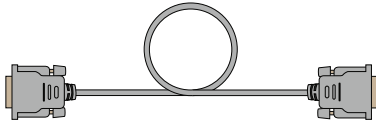

- **CJO-09SS1.5** (1.5M)

Special Order Item

- **CJO-09SS0.3** (0.3M)
- **CJO-09SS5** (5.0M)



- **HR-800** 3CH Thermal Printer use with paper OP050-01TDR

Ethernet Cable

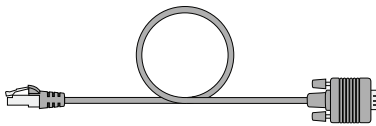

- **CJO-17SS2.5** (2.5M)



- **HP** Network Printer

Accessories

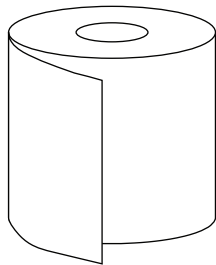

OP050-01TDR
Thermal Roll Paper

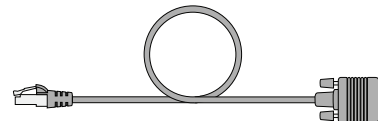

CJO-17SS2.5 (2.5M)
Ethernet Cable



FUKUDA DENSHI USA, INC.
17725-C NE 65th Street Redmond, WA 98052
Toll Free: (800) 365-6668 / Local: (425) 881-7737 / Fax: (425) 869-2018
www.fukudaamerica.com

BIS™, BISx™, Nellcor™ and Microstream™ are registered trademarks of Medtronic. Masimo® is a registered trademark of Masimo. PHILIPS RESPIRONICS® is a registered trademark of Koninklijke Philips. SunTech® is a registered trademark of SunTech Medical, Inc.

The information contained in this document is subject to change without notice.
© 2025 FUKUDA DENSHI USA, INC. All rights reserved.